



# Lux-May

## SUSPENDIDAS - ADOSABLES • LED



LUMINARIA ADOSABLE-SUSPENDIDA  
MICROPRISMA (MCR)  
ALUMAX/MCR-L-110°  
ALUMAX/MCR-XL-110°

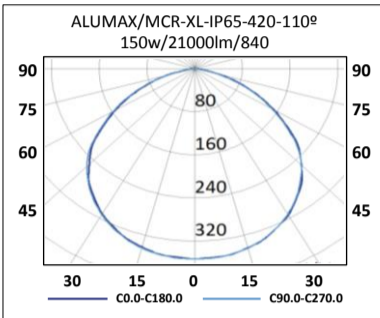

### INDUSTRIALES IP65



ALUMAX MICROPRISMA

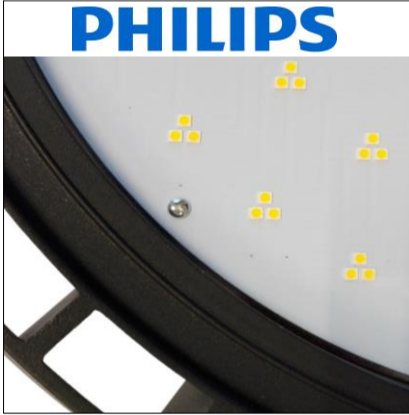

NUEVO DISEÑO  
RENDIMIENTO MEJORADO  
HASTA  
140 lm/W

<b>Montaje</b>	Adosado / Suspendido.	 
<b>Fuente de luz</b>	Módulos LED SMD  (PHILIPS).	
<b>Sistema óptico</b>	Difusor.	
<b>Distribución luminosa</b>	Directa.	
<b>Equipo eléctrico</b>	Equipo de control electrónico regulable (1-10V) EEI=A++. PF>0,95. MEAN WELL. Alimentación 100-240V; 277V. (*)	
<b>Materiales</b>	Cuerpo: Fundición de aluminio de muy alta disipación térmica. Tornillería: Acero inoxidable. Difusor: Cristal templado microprisma antideslumbramiento.	
<b>Acabado</b>	Color negro.	
<b>Beneficios</b>	<p>Luminaria LED con equipo de control electrónico integrado.          Índice de rendimiento de color Ra&gt;80.          Garantía tecnológica.          Óptima curva de iluminación, iluminación homogénea en todo el área de proyección.          Bajo consumo y alta eficiencia.          Larga vida de trabajo &gt;50.000 horas.          No precisa mantenimiento.          Cuidadosa con el medio ambiente, no contiene mercurio.</p>	

28000 lm   140 lm/W   >80 Ra

Montaje

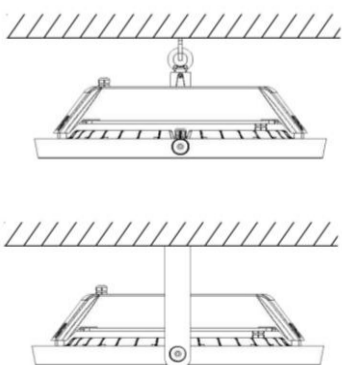

ALUMAX/MCR-L

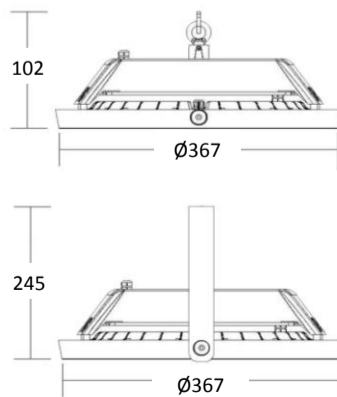

ALUMAX/MCR-XL

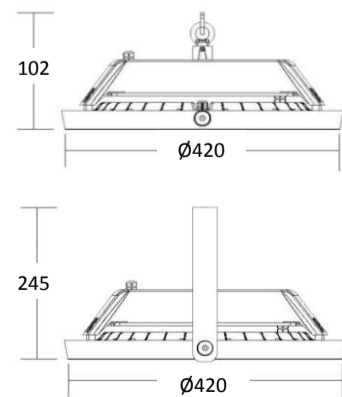

# Lux-May







SUSPENDIDAS - ADOSABLES • 

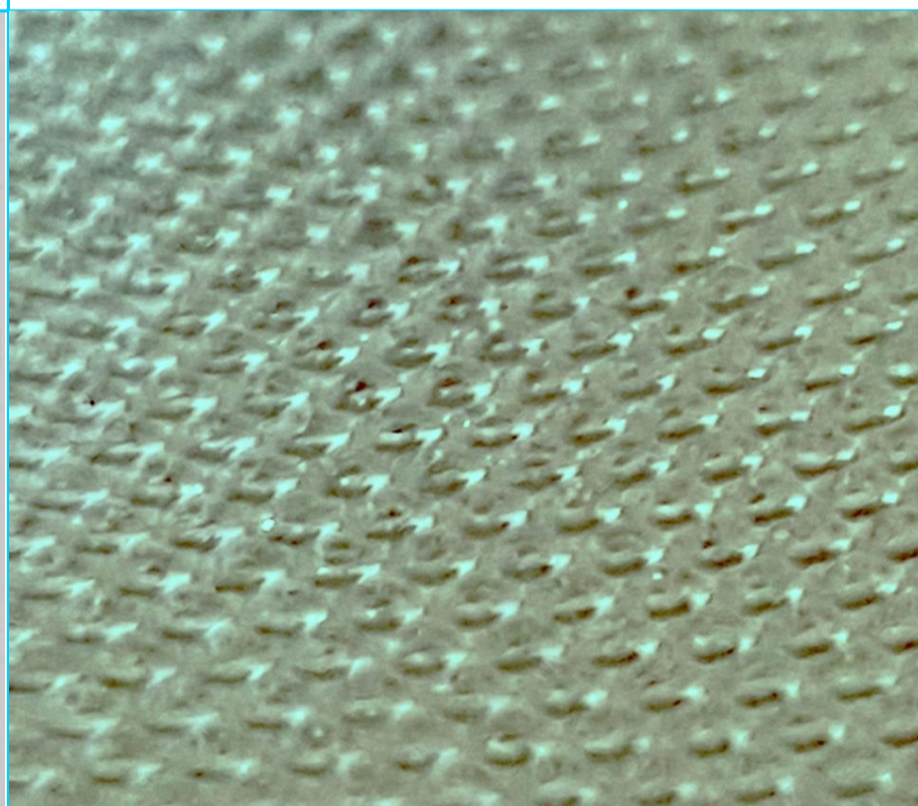
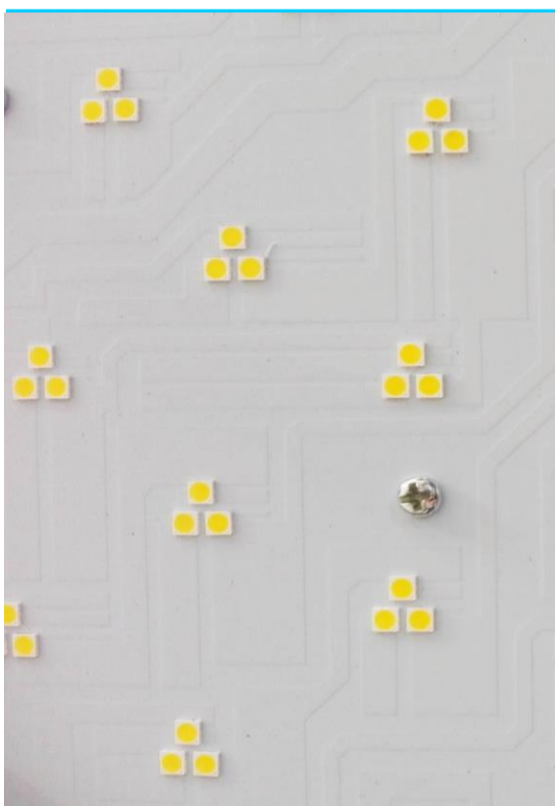
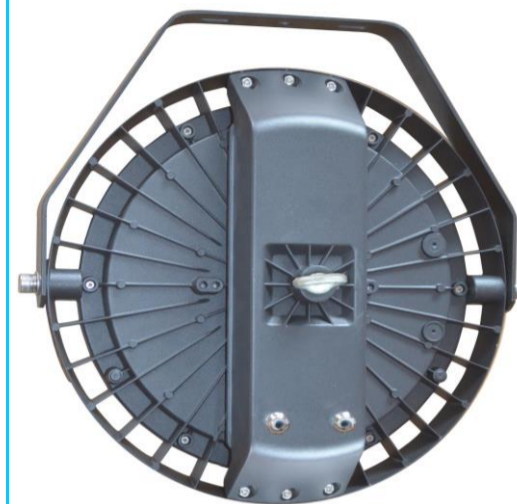
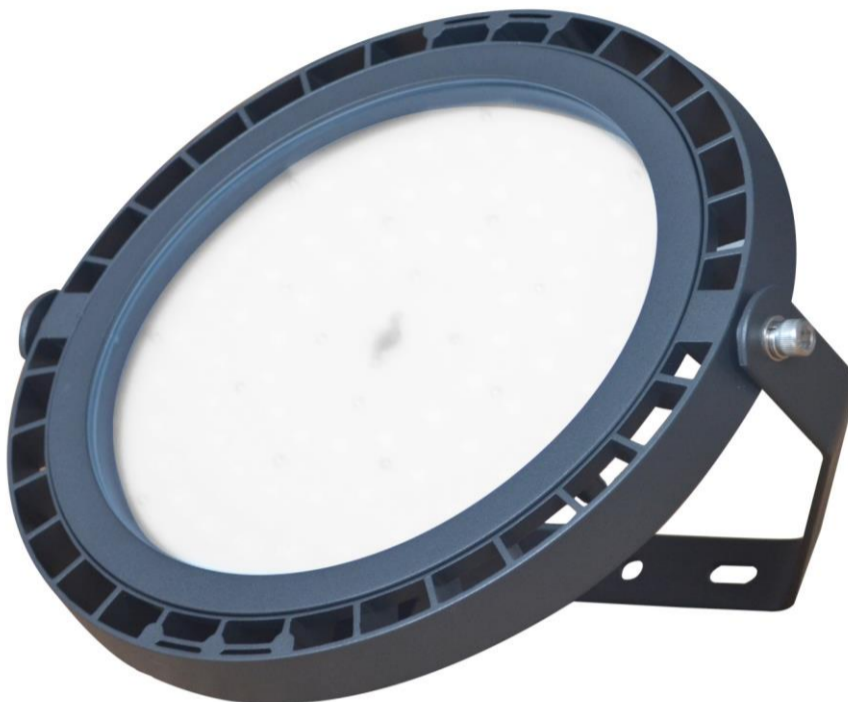

LUMINARIA ADOSABLE-SUSPENDIDA  
MICROPRISMA (MCR)  
ALUMAX/MCR-L-110°  
ALUMAX/MCR-XL-110°

INDUSTRIALES IP65



CODIGO	REFERENCIA	Kg.	Flujo Luminoso lm	Potencia W	Eficiencia Módulo LED + Driver lm/W	Temperatura de color CCT (K)	Angulo de apertura	Regulación 1-10V
ALU0111L1400	 ALUMAX/MCR-L-IP65-367-110°-100w-(1-10V)/14000lm/840	(3,4)	14000	100	140	4000	110°	✓
ALU0111L1401	 ALUMAX/MCR-L-IP65-367-110°-100w-(1-10V)/14000lm/860	(3,4)	14000	100	140	6000	110°	✓
ALU0211L2100	 ALUMAX/MCR-XL-IP65-420-110°-150w-(1-10V)/21000lm/840	(5,1)	21000	150	140	4000	110°	✓
ALU0211L2101	 ALUMAX/MCR-XL-IP65-420-110°-150w-(1-10V)/21000lm/860	(5,1)	21000	150	140	6000	110°	✓
ALU0211L2800	 ALUMAX/MCR-XL-IP65-420-110°-200w-(1-10V)/28000lm/840	(5,6)	28000	200	140	4000	110°	✓
ALU0211L2801	 ALUMAX/MCR-XL-IP65-420-110°-200w-(1-10V)/28000lm/860	(5,6)	28000	200	140	6000	110°	✓
ALU0101L0000	ACC. ALUMAX-L-LIRA SUJECION	-	-	-	-	-	-	-
ALU0201L0000	ACC. ALUMAX-XL-LIRA SUJECION	-	-	-	-	-	-	-

(\*) Alimentación 100-200V: 70% de flujo nominal.